

**ALBERTA GOVERNMENT SERVICES  
LAND TITLES OFFICE**

IMAGE OF DOCUMENT REGISTERED AS:

**151263909**

**ORDER NUMBER: 29438554**

**ADVISORY**

This electronic image is a reproduction of the original document registered at the Land Titles Office. Please compare the registration number on this coversheet with that on the attached document to ensure that you have received the correct document. Note that Land Titles Staff are not permitted to interpret the contents of this document.

Please contact the Land Titles Office at (780) 422-7874 if the image of the document is not legible.

**CAVEAT**

TO THE REGISTRAR OF THE ALBERTA LAND TITLES OFFICE

TAKE NOTICE that **S.R. HOMEOWNERS ASSOCIATION** of Edmonton, in the Province of Alberta, and **SUNSET PROPERTIES INC.**, of Edmonton, in the Province of Alberta (together the "Caveator"), each claim an interest under and by virtue of a Restrictive Covenant in writing, dated September 23, 2015, and made between **SUNSET PROPERTIES INC.**, as registered owner, and the Caveator whereby the said registered owner and the Caveator agreed, all in accordance with the terms of the said Restrictive Covenant, a true copy of which is attached to and forms part of this Caveat, in the lands described as follows:

See Schedule "A" attached hereto. ✓

standing in the register in the name of **SUNSET PROPERTIES INC.**, and the Caveator forbids the registration of any person as transferee or owner of, or of any instrument affecting the said estate or interest, unless the instrument or Certificate of Title, as the case may be, is expressed to be subject to the Caveator's claim.

THE CAVEATOR DESIGNATES 900, 10310 Jasper Avenue, Edmonton, AB, T5J 1Y8, as the place at which notices and proceedings relating hereto may be served.

Dated this 23rd day of September, 2015.

**S.R. HOMEOWNERS ASSOCIATION**  
 Corporate Seal  
 PER: \_\_\_\_\_  
 PER: \_\_\_\_\_

**SUNSET PROPERTIES INC.**  
 Corporate Seal  
 PER: \_\_\_\_\_  
 PER: \_\_\_\_\_

**AFFIDAVIT IN SUPPORT OF CAVEAT**

I, KAREN ALBARDA, of the City of Edmonton, in the Province of Alberta, MAKE OATH AND SAY AS FOLLOWS:

1. That I am Agent for the Caveator.
2. I believe that the said Caveator has a good and valid claim upon the said land and I say that this Caveat is not being filed for the purpose of delaying or embarrassing any person interested in or proposing to deal therewith.

SWORN BEFORE ME Tanya Eklund  
at the City of Edmonton, in the  
Province of Alberta, this 23rd  
Day of September, A.D. 2015

Tanya Eklund

A COMMISSIONER FOR OATHS IN AND  
FOR THE PROVINCE OF ALBERTA

)  
 )  
 ) Karen Albarida  
 ) KAREN ALBARDA  
 )

**TANYA L. EKLUND**  
COMMISSION EXPIRES  
MAY 24th, 2016

**SCHEDULE "A"**

PLAN 151 2560  
BLOCK 23  
LOTS 85 - 99 INCLUSIVE  
EXCEPTING THEREOUT ALL MINES AND MINERALS

PLAN 151 2560  
BLOCK 24  
LOTS 13 - 33 INCLUSIVE  
EXCEPTING THEREOUT ALL MINES AND MINERALS

PLAN 151 2560  
BLOCK 28  
LOTS 1 - 22 INCLUSIVE  
EXCEPTING THEREOUT ALL MINES AND MINERALS

PLAN 151 2560  
BLOCK 31  
LOTS 1 - 13 INCLUSIVE  
EXCEPTING THEREOUT ALL MINES AND MINERALS

**THIS RESTRICTIVE COVENANT**

MADE AS OF THIS 23rd day of September, 2015.

BETWEEN:

**SUNSET PROPERTIES INC.,**  
a body corporate incorporated under the laws of the Province of Alberta  
(hereinafter called the "Grantor/Grantee")

OF THE FIRST PART

- and -

**S. R. HOMEOWNERS ASSOCIATION,**  
a society incorporated under the *Societies Act* of Alberta  
with registered office at 900, 10310 Jasper Avenue  
in the City of Edmonton, in the Province of Alberta, T5J 1Y8  
(hereinafter called the "Grantee")

OF THE SECOND PART

**RESTRICTIVE COVENANT**

WHEREAS:

- a. The Grantor/Grantee is the registered owner of the Dominant Lands and the Servient Lands described in Schedule "A" hereto situate in the Town of Cochrane.
- b. The Grantor/Grantee intends to impose a scheme of mutually enforceable restrictions with respect to the use and improvements on the Lands in order to preserve the integrity of the Development.

NOW THEREFORE:

The Grantor/Grantee as registered owner of the Servient Lands described in Schedule "A" does grant and the Grantor does hereby declare, establish, impose and annex to the Servient Lands and each and every portion thereof for the benefit of the Dominant Lands, the following stipulations, restrictions, guidelines and provisions to run with the Lands and be binding upon the owners from time to time of the Lots:

1. In this Restrictive Covenant, including the preamble, the following words and expressions shall have the meaning herein set forth:
  - a. "**Architectural Committee**" means a committee established by the Grantor/Grantee for so long as the Grantor/Grantee remains an Owner, and thereafter established by the Homeowners Association;
  - b. "**Development**" means the residential subdivision plan within which the Lots are located;
  - c. "**Dominant Lands**" means the leasehold and easement interests of the Homeowner's Association, granted to the Homeowner's Association the lands described in Schedule "A" hereto;

- d. **" Dwelling "** means any residential dwelling constructed on any of the Lots;
  - e. **" Guidelines "** means the Architectural and Construction Guidelines attached hereto as Schedule " B " and as amended from time to time by the Architectural Committee;
  - f. **" Homeowners Association "** means the S.R. Homeowners Association;
  - g. **" Lands "** means the lands described in Schedule ' A ' hereto;
  - h. **" Lot "** means one of the lots described in Schedule ' A ' hereto and any further subdivision of such lots;
  - i. **" Owner "** means a registered owner in fee simple of a Lot;
  - j. **" Restrictions "** means the provisions, restrictions and stipulations contained in Paragraph 2 of this Restrictive Covenant;
  - k. **" Restrictive Covenant "** means this agreement as the same may be amended from time to time and the expressions " herein ", " hereof ", " hereto ", " above ", " below ", and similar expressions if used in any article, section or paragraph of this agreement refer to this agreement including the schedules hereto and do not refer solely to a particular article, section or paragraph unless specifically stated herein;
  - l. **" Servient Lands "** means the lands described as such in Schedule ' A ' hereto.
2. For each of the Lots comprising the Servient Lands, for the benefit of the Dominant Lands, the following restrictions, stipulations and provisions are to run with the Lands, namely:
- a. No motor homes, recreational vehicles, trailers, boats or similar vehicles shall be stored for any period exceeding seven (7) days or for any period aggregating fourteen (14) days in a twelve month period on the front driveway, nor on the side yard, nor on any driveway of any building on any of the Lots, unless within an enclosure approved by the Architectural Committee, or as required by Municipal Bylaw as amended from time to time.
  - b. No satellite dishes shall be constructed, installed, placed, kept or maintained on any roof, front or side yard of any Dwelling, unless first approved by the Architectural Committee;
  - c. No radio or television aerials or antenna of any kind shall be erected, constructed or placed on any Dwelling or on any of the Lots, unless first approved by the Architectural Committee and unless the said aerial or antenna is a single unit incorporated into the structure of the Dwelling;
  - d. No construction of the Dwelling may commence unless the building plans have been approved by the Architectural Committee;
  - e. No dwelling may be constructed unless said Dwelling conforms with the Guidelines attached hereto as Schedule " B ";

- f. The driveway width for all semi-detached dwellings with a front attached single garage will be limited to the width of the garage only.
  - g. Secondary/accessory suites are prohibited on all front drive semi-detached dwellings.
3. If any of the Restrictions herein or the application thereof to any part or any circumstances shall be held by any Court of competent jurisdiction to be invalid or unenforceable to any extent, then such Restriction shall be severed from the remainder of this Restrictive Covenant, and the remainder of this Restrictive Covenant or application of such Restriction to a party or circumstance other than those to which it is held invalid or unenforceable shall not be affected thereby and each of the remaining Restrictions of this Restrictive Covenant shall be valid and enforceable to the fullest extent permitted by the law.
  4. This Restrictive Covenant is in addition to the requirements of the municipal or other government authorities having jurisdiction in respect of the use of the Lands, and nothing contained herein shall be construed as permitting or authorizing anything which is prohibited, controlled or regulated by any statute, bylaw, regulation or like enactment having the force of law and having application to the lands.
  5. Nothing herein shall require or oblige the Grantee to enforce this Restrictive Covenant or render the Grantee liable for the failure of any of the Owners from time to time of the Lots to adhere to or conform with the Restrictions contained in this Restrictive Covenant, it being the intention to attach to each of the Lots and the Owners thereof the obligation for compliance with this Restrictive Covenant.
  6. The Restrictions contained in this Restrictive Covenant shall be binding upon and enure to the benefit of the Owner from time to time of each of the Lots and the Grantee and the restrictions herein shall run with the Lands and each of the Lots.

IN WITNESS WHEREOF these presents have been executed by each of the parties hereto the day and year first above written under its corporate seal and by the hands of its officers duly authorized in that behalf.

SUNSET PROPERTIES INC.  
Corporate  
Per: \_\_\_\_\_  
Per: \_\_\_\_\_ (seal)

S. R. HOMEOWNERS ASSOCIATION  
Corporate  
Per: \_\_\_\_\_  
Per: \_\_\_\_\_ (seal)

**SCHEDULE "A"**  
**TO RESTRICTIVE COVENANT AGREEMENT**

---

The Current Lots are legally described as follows, all being lots shown on the subdivision plan registered as Plan No. 151 2560, namely:

Block 23, Lots 85 to 99 inclusive

Block 24, Lots 13 to 33 inclusive

Block 28, Lots 1 to 22 inclusive

Block 31, Lots 1 to 13 inclusive

**SCHEDULE "B"**

**ARCHITECTURAL AND CONSTRUCTION GUIDELINES**

---

# Sunset Ridge

— IN COCHRANE BY —

MELCOR  
DEVELOPMENTS LTD.

## PHASE 19B ARCHITECTURAL GUIDELINES

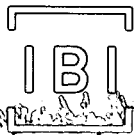
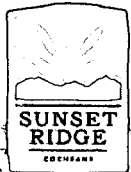

July 2015

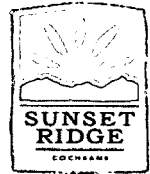

## TABLE OF CONTENTS

1.	INTRODUCTION	1
1.1	Architectural Guidelines	2
1.2	Intent and Theme	2
2.	LAND USE ZONING	3
2.1	Land Use Bylaw	3
2.2	Zoning Regulations	3
2.3	Minimum Home Sizes	4
2.4	Driveways	4
2.5	Accessory Buildings	4
3.	SITING	5
3.1	House Placement	5
3.2	Maximum Side Yards	6
	3.2.1 Interior Lots	6
	3.2.2 Corner Lots	6
3.3	Lot Grading	7
4.	ARCHITECTURAL DESIGN	8
4.1	Proposed Housing Product	8
4.2	Repetition	8
4.3	Architectural Theme & Style	8
	4.3.1 Craftsman/Arts and Crafts	9
4.4	Building Form and Massing	10
	4.4.1 Roof Design and Pitch	11
	4.4.2 Corner Lots	11
	4.4.3 Front Porches	12
	4.4.4 Enhanced Porches	12
	4.4.5 Rear Elevations	13
	4.4.6 Exterior Decks and Patios	13
	4.4.7 Chimneys	13
	4.4.8 Retaining Walls	14
	4.4.9 Columns	14
	4.4.10 Gable Treatment	14
5.	BUILDING MATERIALS AND COLOURS	15
5.1	Primary Wall Materials	15
5.2	Exterior Colours	16
5.3	Masonry	16
5.4	Trim, Fascia, and Soffit	17





## TABLE OF CONTENTS

5.5	Windows	17
5.6	Roofing	18
5.7	Roof Hardware	18
5.8	Front Doors	18
5.9	Garage Doors	19
5.10	Railing	20
5.11	Driveways and Sidewalks	20
5.12	Front Steps	20
5.13	Lighting	20
6.	<b>ADDITIONAL REQUIREMENTS</b>	21
6.1	Recreation and Commercial Vehicles	21
6.2	Satellite Dishes	21
7.	<b>LANDSCAPING</b>	22
7.1	Fencing	22
7.2	Front Yard Landscaping	22
7.3	Fire Pits and Outdoor Fireplaces	22
8.	<b>APPROVAL PROCESS</b>	23
8.1	Preliminary Review	23
8.2	Formal Application Submission	23
8.3	Final Inspection	23
8.4	Schedule of Applicable Fees	23
9.	<b>CONSTRUCTION REGULATIONS</b>	24
9.1	Material and Equipment Storage	24
9.2	Use of Site	24
9.3	Vehicles and Parking	24
9.4	Other Notes	24
10.	<b>DISCRETION</b>	25
10.1	No Right to Enforce	25
10.2	Right to Amend	25
10.3	No Trespassing	25
11.	<b>CONTACTS</b>	26
	APPENDIX A: SIDING COLOURS	
	APPENDIX B: FENCING	
	APPENDIX C: LAND USE BYLAW	





## 1. INTRODUCTION

Sunset Ridge is a master planned residential community located in the Town of Cochrane, Alberta. Sunset Ridge is accessed from Highway 22 North and consists of a wide variety of housing options ranging from multifamily homes to starter single family homes to estate single family homes.

These Architectural Guidelines have been written for Phase 19B of Sunset Ridge which consists of single detached homes and townhomes homes. The lot sizes will vary. Each lot in Sunset Ridge will be unique and will offer exciting building opportunities.

Traditional inspired homes will be built using modern building materials and techniques. In order to recognize this inspiration, the home styles in Sunset Ridge will be derived by an interpretation of Craftsman and Arts and Crafts architecture.

To ensure that the built form remains true to the selected styles, the Architectural Committee has commissioned IBI Group to be the interim Architectural Coordinator for the community. IBI Group will review all home plans submitted by the builders for conformance of these guidelines. This responsibility will be assumed by the Architectural Committee once assigned by the Developer.

**It is recommended that all purchasers obtain a copy of all restrictive covenants prior to signing their home purchase agreements.**

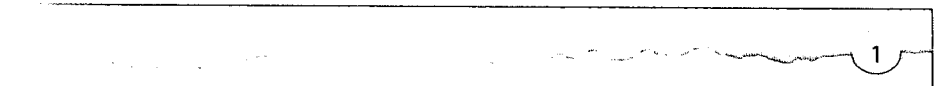



## 1.1 Architectural Guidelines

Architectural Guidelines will be implemented in Sunset Ridge Phase 19B to ensure that all builders will design and build homes to meet standards that are envisioned by the Developer.

The Architectural Guidelines will enhance the integrity of the development and ensure that each home that gets built will add value to the community. The Architectural Guidelines have been prepared to promote a high level of architectural detail, ensure a pleasing building form, and promote an awareness of environmental sustainability.

## 1.2 Intent and Theme

The intent of these guidelines is to create a community of harmony and continuity while maintaining a number of traditional architectural styles to offer variety and flavour.

Architectural styles other than Craftsman and Arts and Crafts will be considered in Sunset Ridge Phase 19B and will be carefully reviewed by the Architectural Committee to ensure that the style will blend with all of the homes in the development.





## 2. LAND USE ZONING

The Architectural Committee will complete a review of all house plans to ensure compliance. An "Approved" stamp must be issued prior to the builder submitting a building permit application to the Town of Cochrane. All construction must comply with the current Town of Cochrane Land Use Bylaw and Alberta Building Code. Construction may only begin upon receipt of a building permit from the Town of Cochrane and a Grade Slip from the Architectural Committee. Conformity with the Guidelines does not supersede the required Town of Cochrane approval process.

### 2.1 Land Use Bylaw

Sunset Ridge Phase 19B is comprised of R-1 and R-3 lots. All homes will be subject to all land use rules established in the Town of Cochrane Land Use Bylaw. If the Land Use Bylaw is revised at any time, all lots will follow the Land use Rules of the revised Land Use Bylaw. The land use breakdown is as follows:

#### SINGLE DETACHED HOMES

R-1	Block 23	Lots 85-99	Double Front Garage
	Block 31	Lots 1-13	Double Front Garage

#### TOWNHOMES

R-3	Block 24	Lots 13-33	Laned
	Block 28	Lots 1-29	Laned
	Block 31	Lots 14-31	Laned
	Block 34	Lot 1-13	Laned

### 2.2 Zoning Regulations

All homes in Sunset Ridge Phase 19B will follow the regulations noted in the appropriate Land Use District in the Town of Cochrane Land Use Bylaw. For convenience the R-1 and R-3 sections of the Land Use Bylaw along with the General Regulations for Residential Districts can be found in Appendix C.



## 2.3 Minimum Homes Sizes

The Developer has established the following minimum homes sizes for Phase 19B of Sunset Ridge. The minimum floor area is for total floor area above grade and does not include attached garages or any basement floor area.

### R-1 Zoning - Double Front Garage

<b>Block 23 Lots 85-99 and Block 31 Lots 1-13</b>	
<b>Two Storey:</b>	<b>1,800 ft<sup>2</sup></b>
<b>Bungalow and Split Level:</b>	<b>1,400 ft<sup>2</sup></b>

### R-3 Zoning - Townhomes Laned

<b>Block 24 Lots 13-33, Block 28 Lots 1-29, Block 31 Lot 14-31, and Block 34 Lots 1-13</b>	
<b>Two Storey:</b>	<b>1,000 ft<sup>2</sup></b>
<b>Bungalow and Split Level:</b>	<b>700 ft<sup>2</sup></b>

The Split Level square footage calculation will include the entire footprint of the home excluding the garage. Split level homes must have the same footprint or larger than the minimum required for a bungalow.

## 2.4 Driveways

- Driveway length must be a minimum of 6.0 metres from the property line to the face of the garage wall.
- Desirable driveway slopes are between 3% and 7%.
- Maximum Driveway slope is to be 10%; minimum is to be 2%.
- A minimum of 1.2 metres is required between driveways and side property lines. This may be relaxed on pie shaped lots at the discretion of the Architectural Coordinator.
- The driveway width for front drive Semi-Detached homes will be limited to the width of garage only.

## 2.5 Accessory Buildings

Accessory buildings will be permitted and must follow the rules of the Town of Cochrane Land Use Bylaw and are to be designed to match the style and building materials of the principal residence.



### 3. SITING

#### 3.1 House Placement

Builders are required to choose proper home designs around the approved grading and site topography to take full advantage of views and to maximize lot space. Designers are to take into consideration the lot width, length and shape as houses should be conforming to these sizes. Builders and designers are required to review the Building Grade Plan and Marketing Plan prior to designing the home. Homes on pie shaped lots should be sited in a radiating pattern rather than parallel to an adjacent side property line.





## 3.2 Maximum Side Yards

### 3.2.1 Interior Lots

- The preferred combined side yard for all interior lots in Sunset Ridge Phase 19B will be 8' (2.44m) (i.e. a 30' dwelling on a 38' lot). The distance will be measure from the side property line to the foundation wall on both the front and the rear of the dwelling.
- A maximum combined side yard of 10' (3.05m) (i.e. a 28' dwelling on a 38' lot) for all interior lots will be permitted providing that a minimum 2' (0.61m) garage offset is provided or a minimum 2' (0.61m) porch extension is provided.

### 3.2.2 Corner Lots

- A maximum combined side yard of 14' (4.27m) will be permitted on corner lots providing that the following conditions have been met;
  - The maximum dwelling width must be 10' (3.05m) less than the lot width noted on the Marketing Plan (i.e. a 28' dwelling on a 38' lot).
  - A minimum 3' (0.91m) wraparound porch width is provided.
  - Builder may choose to extend the rear deck to meet the 14' (4.27m) combined side yard on corner lots, where possible.

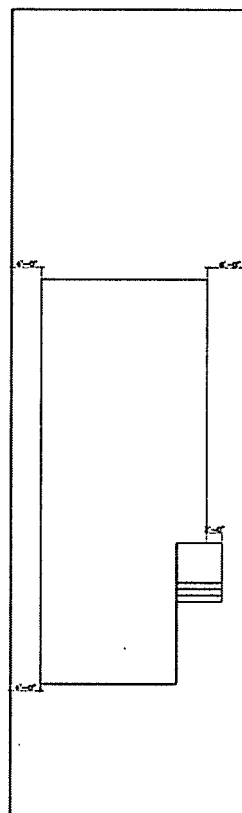
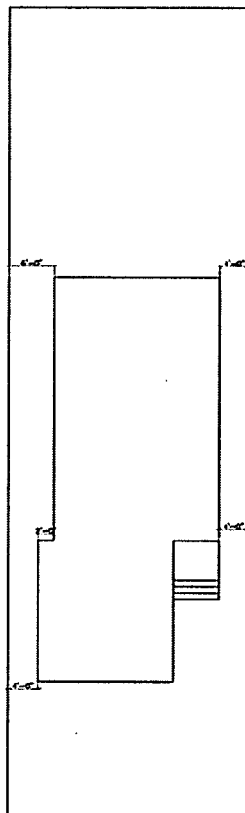



### 3.3 Lot Grading

Lot grading must be in compliance with the Town of Cochrane Surface Drainage Bylaw 13/2005. Builders should give due consideration to building grades when determining house types in order to assure that an appropriate house is located on each homesite. Lot slopes should be absorbed within the building massing as much as possible.

- Builders must pay close attention to drainage patterns created on the homesites in order to ensure surface water is channelled away from the house on all sides and into adjacent drainage swales and storm water systems.
- Builders are to ensure that all of the corner and intermediate elevations, as established by the development engineer, be maintained exactly as specified.
- Maximum permitted front, rear or side yard slope is 3:1, builders are encouraged to stay within 5% - 25% slope.
- The lot grades create a drainage pattern, as indicated on the "grade plan", and must be maintained.
- Site drainage must be established prior to commencing construction and maintained by the builder throughout the construction period.
- Individual lot grading (including drainage swales and retaining walls) must be completed within individual home site property lines.





## 4. ARCHITECTURAL DESIGN

### 4.1 Proposed Housing Product

Single family homes and Townhomes will be offered in Sunset Ridge Phase 19B. Certain lots have been designed to accommodate front drive garages. To reduce the visual impact of the front attached garages builders will be asked to pay special attention to the form and finish of the garage so that it complements the character of the principle dwelling. Living space should be incorporated over the garages, and it is encouraged that the front entries of the homes be brought forward and shall be designed to emphasize the entrance as the focal point of the dwelling. Detailed carriage style garage doors will be required at minimum and real wood garage doors will be encouraged to create a distinctive streetscape.

### 4.2 Repetition

Single family home and individual Townhome Unit designs with near identical house elevations and colours may not be repeated more often than every fourth (4th) home on the same side of the street and every third (3rd) home on the opposite side of the street.

To be different means that there is a significant change in features such as roof type, size and location of windows and doors, colours and finish materials. A change of materials alone and reversing the plan is not sufficient.

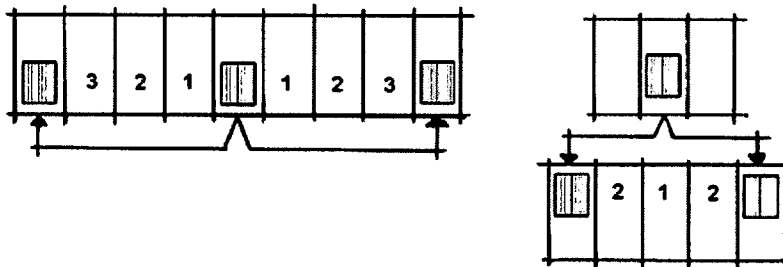

### 4.3 Architectural Theme & Style

Craftsman and Arts and Crafts will be the preferred architectural style for Sunset Ridge Phase 19B; however other styles may be approved at the discretion of the Architectural Coordinator. Please refer to section 4.5 "Architectural Style" for a detailed description of these styles.

**Note:** The Developer and the Architectural Coordinator reserve the right to accept home designs which, in the opinion of the Architectural Coordinator, meet the intent of Architectural Guidelines set out herein in all respects.



### 4.3.1 Craftsman / Arts and Crafts

The preferred architectural styles for Phase 19B of Sunset Ridge will be Craftsman and Arts and Crafts. Other architectural styles may be permitted at the discretion of the Architectural Coordinator.

Craftsman homes generally have moderate pitched roofs, while Arts and Crafts are steeper in pitch. Both styles may include second storey dormers, covered front verandas, decorative beams or braces and the use of traditional building materials in deep rich colours. It is encouraged that the upper floor living space of two storey homes be built into the roof massing.

Siding and trim colours should be inspired by natural surroundings and should complement the natural materials used on the home.

Masonry is essential for these styles and should only be used on the base to ground the home to add a presence of stability.

Masonry heights may vary but the thickness should always be much greater than the pier. Elements like brackets, blocks, false trusses and exposed rafter tails are encouraged to give the presence of craftsmanship.

#### Craftsman Elements:

- Moderate roof pitch
- Use of stone or brick and natural materials
- A high level of architectural detailing on doors and windows
- Wood blocks and brackets

#### Arts and Crafts Elements:

- Steeper roof pitch
- Alternate materials used on upper floor
- Board and batten detailing in contrasting colours



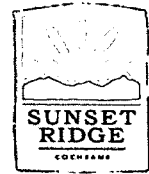

## 4.4 Building Form and Massing

### R-1 Zoning (Front Attached Garages)

- A minimum of a double front attached garage will be required on these lots. The attached garage should reflect and complement the overall massing and proportion of the home and not dominate the streetscape. Triple car garages may be approved at the discretion of the architectural coordinator and must have at least one bay of the triple garage recessed or extended out 12" from the others.
- If the third bay of the garage is fully offset from the main body of the home, special attention must be paid to the roof design and massing in order to integrate the third garage bay into the overall appearance of the home. Attached triple car garages must be a natural extension of the design, massing and materials of the main dwelling.
- In order to reduce the visual impact of front drive garages, close attention will be paid to the architectural design of the front elevation and the design of the front entryways. One method in achieving this is bringing the front entryway of the home as far forward as possible, without adversely affecting the interior layout of the home. Deeper porches and roof lines that extend past the steps are highly encouraged to provide a better sense of enclosure over the entry.
- The garage location is noted on the building grade plan and the subdivision marketing plan. Builders are required to use the garage location as shown unless otherwise approved by the developer.
- Extra wide double car garages shall not be permitted unless otherwise approved at the discretion of the architectural coordinator.
- If a side drive garage configuration is chosen, the garage should stay in the same location as if it were a front drive garage.
- Garages will generally be paired with the neighbouring homes unless noted otherwise on the subdivision marketing plan.

### R-3 Zoning (Townhomes)

Individual entrances should be emphasized through roof articulation, front porches and other treatments.

All townhomes will be required to have extensive articulation in the design and elevations. Each unit in the townhome is to be modestly offset from the neighbouring unit to provide this articulation. Covered porches will be required on each townhome unit to break up the massing of the front elevation. Bold colour schemes and contrasting trim will be mandatory. Multiple rooflines shall be used to create articulation in the streetscape. Long straight rooflines and wall planes will not be permitted.



#### 4.4.1 Roof Design and Pitch

The roof design is important to achieving the desired look of the Craftsman / Arts and Crafts design. Rooflines should generally consist of gable roofs and a minimum of 6/12 roof pitch will be required on all homes. Roof vents and plumbing stacks must be located away from the street view of the house where possible.

- Overhangs on all roof configurations shall be a minimum of 18".

#### 4.4.2 Corner Lots

Corner lots that side onto a street or open space will require substantial additional treatment. The side elevation shall be well articulated with various architectural elements appropriate for the overall design of the house. Battens will be required on openings. Other elements may include box outs, rooflines or verandas that wrap around the exposed building face shall be the preferred treatment, chimneys and fully detailed windows, and shadow bands.

Lots that require this treatment:

Block 23 - Lot 99

Block 36 - Lots 1, 13, 14, and 31

Block 24 - Lots 13 and 33

Block 37 - Lots 1 and 13

Block 28 - Lots 1 and 29



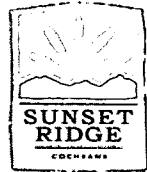

#### 4.4.3 Front Porches

All homes shall incorporate a front porch into their designs to integrate with the streetscape and must be maximized in size and length to provide a more pedestrian friendly environment. The use of a porch on front attached garage homes will also help reduce the distance from the garage face to the front entry. To ensure the functionality and correct massing a minimum depth of 6 feet will be required for all porches for single detached homes and townhomes with 4' porch roof extension. If a design is submitted that does not have a full front porch but has adequate detail and massing it may be accepted at the discretion of the Architectural Coordinator.

The underside of the porch is to be screened in an appropriate and complementary material so that the underside of the porch is not visible. Lattice will not be permitted. Stone, brick, panelling, board and batten or shake are permitted as skirting materials. Front steps and landing are encouraged to be constructed of concrete, but wood or other alternate material will be permitted.

#### 4.4.4 Enhanced Porches

When the lots have extra width available to them, a wraparound porch or extended width porch shall be considered, unless otherwise approved at the discretion of the architectural coordinator. This is especially important on reverse pie shaped lots where the front is significantly wider than the rear of the lot, corner lots, and the larger 36 feet and 38 feet amenity lots. When provided, a wraparound porch should return at least 3' from the foundation corner, while an extended width porch will require a depth of at least 8' for Single Front Attached and 6' for Semi-Detached Homes and Townhomes. Wraparound porches are to be considered in the design on:

Block 23 - Lot 99

Block 31 - Lots 1, 13, 14, and 31

Block 24 - Lots 13 and 33

Block 35 - Lots 1 and 13

Block 28 - Lots 1 and 29

An extended width porch is required for all other lots with extra width available to them. If an enhanced porch is not provided as per the standards in this section, the landing/porch off the principal entrance to the home will require additional architectural detailing.



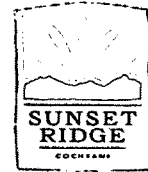

#### 4.4.5 Rear Elevations

All rear elevations will require some additional detailing that will include at the minimum battens around openings. Large exposed flat walls will not be permitted. Designers will be required to articulate rear elevations to breakup the vertical massing. This can be achieved through the use of decks, rooflines and by stepping back the upper floor where warranted.

Rear elevations that back onto open space or onto a corner lot will require the same level of detailing as the front elevation.

#### 4.4.6 Exterior Decks and Patios

Railings will be required as per the Alberta Building Code. Front porches, landings and rear decks shall have railings in a style to match the architectural theme of the home. Supporting columns for decks and porches are to be architecturally detailed and must have a minimum dimension of 300mm square (12" x 12"). The cap and base of the columns must be detailed and built out.

All walkout homes regardless if they are visible from the street or open space will require the decks with (12" x 12") built out columns to be shown on the plans and built at the time of construction of the home.

#### 4.4.7 Chimneys

Chimneys must be finished to match the exterior wall material. Stone or brick finishes on chimney chases are highly recommended on all homes. On corner lots builders are required to bring the chimneys down to grade and are encouraged to be constructed full height chimneys that would extend past the upper floor level.





#### 4.4.8 Retaining Walls

Where retaining walls are required it is recommended that they are constructed using natural materials, i.e., sandstone boulders, rundle rock or river rock (mortar). Retaining walls not constructed from natural materials should be constructed with a visually aesthetic material, i.e., decorative concrete, or concrete with a stone or brick facing. Concrete wing walls will be acceptable when not visible from the street and require approval from the Architectural Coordinator.

Retaining walls will be limited to a height of 4 feet (1.22 metres). All retaining structures must be within property lines. Any retaining wall exceeding 1.00 metre in height **MUST** be approved by a professional engineer and may require a development permit.

In no instance shall a retaining wall be introduced to a lot to artificially revise the grades approved on the building grade plan unless otherwise approved by the developer.

#### 4.4.9 Columns

All columns must be boxed out in crezone or smartboard detailing (siding not pemritted on columns) and be a minimum size of 12"x12", they should show structural integrity and have a rich level of detailing to reflect the traditional style of the home. All porch columns must return to grade wherever possible.

#### 4.4.10 Gable Treatment

All gables on front and side elevations facing a street, and rear elevations backing onto open space will require additional decorative detailing and an alternate material. Siding on its own will not be allowable on these gables. A horizontal batten separating the main wall and the gable is suggested, as shown below.

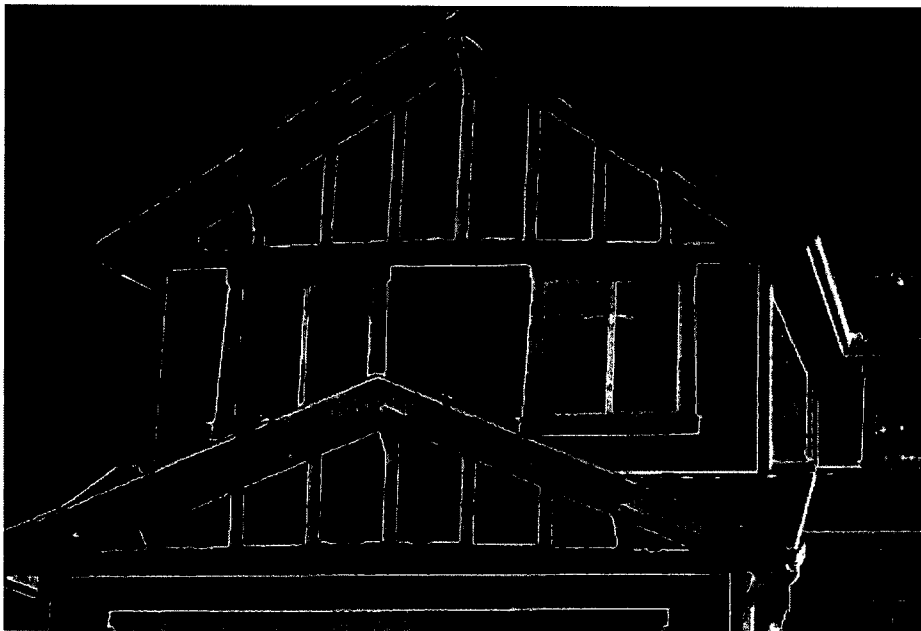



## 5. BUILDING MATERIALS AND COLOURS

### 5.1 Primary Wall Materials

- Vinyl siding with a Beveled/Traditional lap profile in a premium dark colour will be the minimum requirement. Smooth finish stucco and composite siding will also be approved as an upgrade. **Dutch Lap siding will not be permitted.**
- Secondary wall materials may include smooth composite panels, cedar shakes and composite shakes. Vinyl shakes may be approved at the discretion of the architectural coordinator on lots where vinyl siding is permitted. Vinyl shakes are to be in a straight cut profile. Other alternatives may be approved at the discretion of the Architectural Coordinator.
- Before submitting colours builders should review adjacent house colours to avoid repetition.





## 5.2 Exterior Colours

Approved primary siding colours can be found in Appendix A. Alternate colours not listed in Appendix A may be approved at the discretion of the Architectural Coordinator.

Siding and stucco colours must be a dark, rich hue for the primary wall material. Pastel and light shades of colour will not be permitted.

It is the intent in Sunset Ridge to highlight the streetscape with interesting vibrant colour schemes. To achieve this, a secondary material will be required on the front, exposed side, and rear elevation of every home. Secondary colours must offer a striking contrast to the main body of the home, not a lighter or darker shade of the same colour.

Painted trims must be completed in a contrasting colour to the primary and secondary wall materials that provides interest to the home's detailing.

Garage Doors must be painted to match the main siding colour and the batten and trims painted to match the main trim colour of the home. Doors that are painted a wood colour may be approved at the discretion of the Architectural Coordinator.

## 5.3 Masonry

The use of masonry will be encouraged on all homes in Sunset Ridge Phase 19B and should be used in portions reflecting structural integrity. There will be no minimum amount of stone or brick required but the placement of the material must ground the home and act as a structural element. All stone or brick must wrap at least three feet around all corners. It is highly encouraged and in cases where the distance between the face of garage and the porch exceeds 10 feet, masonry or alternate material on the front of the garage will be required to return along the length of the garage wall to the face of the porch or pillars. The end of the return will need to be finished with trim that sits proud. Only natural stone, manufactured stone and brick will be permitted as masonry materials.

Designs with no masonry may be accepted at the discretion of the Architectural Coordinator. These homes will require extensive detailing and trim elements to compensate for the lack of masonry detailing.

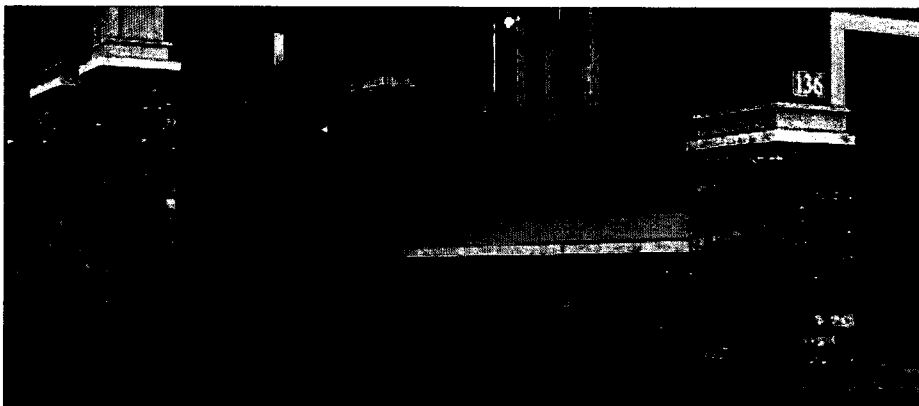



## 5.4 Trim, Fascia and Soffit

Modern trim materials used in a traditional manner will assist the homes in Sunset Ridge Phase 19B to appear traditional and timeless. Designers are asked to put a great deal of efforts into the trim detailing.

- Trim around windows and door openings will be required on the front and rear elevations of all homes, including the side elevations of corner lots and lots located beside public open spaces.
- Trim detailing around all openings is highly encouraged for all non-exposed rear elevations. However, if the home is offset at least three lots from a street corner, a relaxation to the trim requirements around opening on the main level will be permitted. Full trim detailing on all openings will be required if the home is within three lots of the street corner.
- Trim material shall be Smartboard or equivalent. Smooth finish acrylic stucco battens will also be acceptable.
- When composite or vinyl siding is chosen as the primary wall material, 4" minimum composite corner boards will be required on the front elevation and will also be required on elevations that are visible from open spaces. Corner boards are suggested when using stucco as a wall finish, but it is not required. **Corner boards are to match the trim colour used on the home.**
- Shadow boards or cornices, if incorporated in the design, shall be used in all open gable ends where the wall meets the soffit on all front and rear elevations.
- The fascia on open gables on the front and other highly visible elevations is to be constructed with a composite material. All other fascia may be aluminum. All fascias must be a minimum of 8 inches in height.
- Rainware should be limited on exposed elevations. Downspouts should take place on side and rear elevations of homes only. Rainware should match colour of soffit and fascia used on home.

## 5.5 Windows

- Casement, double-hung, and single-hung are appropriate window types and may be incorporated with non functional windows to create more elaborate window designs. Sliding windows in bedrooms will be acceptable.
- Townhouse units shall have coordinated window placement.
- Skylights, if used, should be black in colour to match the roofing and should have a flat profile. Skylights should be incorporated on rear elevation and should not be visible from the street.

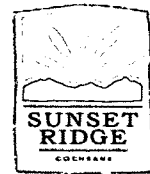

## 5.6 Roofing

The roof material for all homes is to be premium architectural asphalt shingles such as IKO Cambridge 30, recycled rubber composite shingles, or concrete tile in the slate profile with a dark colour. Other equivalents or upgrades may be approved but will be to the Architectural Coordinator's discretion. No wood shakes will be allowed. All roof stacks must be enclosed and/or finished to compliment the roof colour and exterior finish detail.

**Dual Black or an equivalent will be the approved roofing colour when asphalt shingles are used.**

Rainwater leaders and soffits shall match or compliment the approved trim colour.

## 5.7 Roof Hardware

All roof hardware (vents, stacks, flashing, etc.) must be prefinished or painted to match the colour of the roofing material. **Unfinished galvanised flashing will not be permitted.**

## 5.9 Front Doors

- Front entry doors are to compliment the architectural style of the home.
- Entry doors are to have glazing and/or sidelights and/or transom windows.
- Single or double front entry doors are allowed. Double front entry doors will be approved at the discretion of the Design Coordinator.
- Sliding patio doors shall not be located on front elevations.





## 5.10 Garage Doors

- Garage doors are to be as unobtrusive as possible so they do not dominate the facade of the building and shall be designed to complement the character of the dwelling.
- Must be a traditional carriage or renaissance style with vertically proportioned panels and raised trim. This will give the appearance that the door has been constructed of wood. **Panelled steel garage doors may be used for detached garages that back onto a lane.**
- Are not to exceed 8 feet in height and 20 feet in width unless approved by the Design Coordinator.
- White garage doors will not be approved unless the trim colour on the home is approved as white.
- Additional space above the garage door to eaves line (more than 24 inches) will have to be justified and treated with an architectural feature.
- The same garage door style will not be permitted to be side by side, there must be at least one house of separation.
- All garage doors are to be painted in a similar manner to the panelling on the home. The background of the door is to be painted the panel colour and the batten in the contrasting trim colour.
- To further enhance the front facade of the homes, it is recommended that all garage doors include glazing panels in a design that suits the home's exterior and the garage door style. Glazing panels will be required on all doors that exceed 7 feet in height. They will also be required on all homes that do not include masonry.

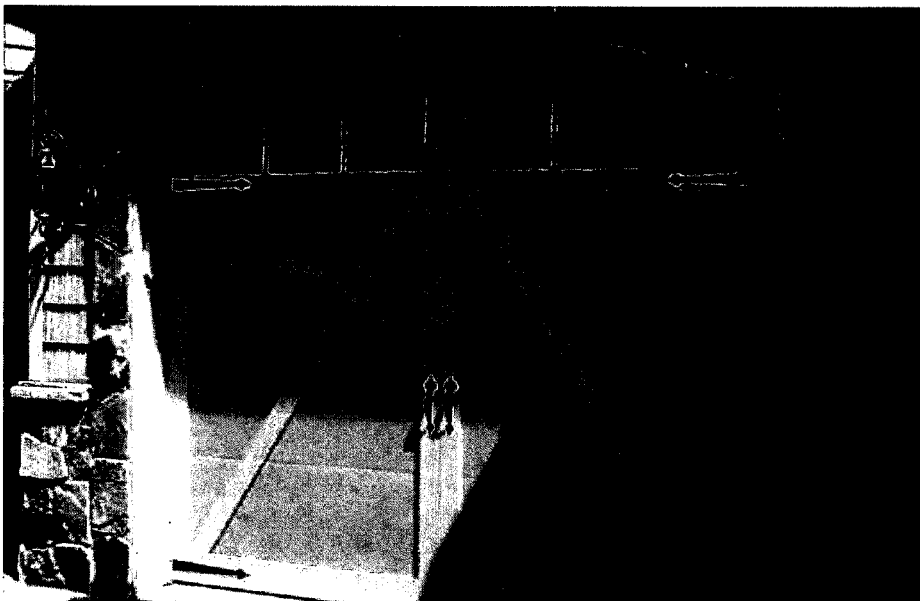

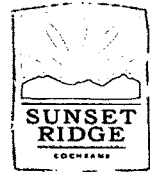

## 5.11 Railing

Acceptable railing materials include:

- Wrought iron/aluminum
- Glass panel (rear only)
- Wood railing in a decorative design may be approved on front verandas only and must compliment the design.

## 5.12 Driveways and Sidewalks

Exposed aggregate finish is highly encouraged for all front attached homes. However broom finished concrete will also be permitted in Phase 19B.

All driveways are to have a joint 2.4 metres from the back of curb. This will reduce damage to driveways as a result of water valve maintenance.

The width of all front driveways shall not exceed the width of the garage face. In no instance shall front yard landscaping be removed and replaced with hard surface such as poured concrete, paving stones, asphalt, concrete blocks, decorative concrete, etc. The approved plot plan showing the extent and dimension of the front driveway shall remain valid and in force in perpetuity unless otherwise authorized by the Developer.

Sidewalks leading up to the home from the driveway are to match the concrete that was used for the driveway.

Driveways must be at least 1.2 metres from the side property line. This may be relaxed for pied shaped lots at the discretion of the Architectural Coordinator.

## 5.13 Front Steps

Decorative concrete is encouraged. Steps which have a combination of smooth concrete and exposed aggregate will also be approved.

Alternate materials may be approved for the front steps at the discretion of the Architectural Coordinator if the materials are high quality and compliment the design of the home.

## 5.14 Lighting

Exterior lighting will be required on the garage and front entry. Recessed pot lighting is encouraged; however decorative coach lamps will be acceptable.



## 6. ADDITIONAL REQUIREMENTS

Nothing herein contained shall be construed or implied as imposing on the Developer, its agents or employees, any liability in the event of non-compliance with or non-fulfillment of any of the terms, restrictions and benefits set forth herein and no liability or responsibility whatsoever shall be incurred by the Developer, its agents or employees, in the performance or non-performance of their rights and obligations herein.

### 6.1 Recreation and Commercial Vehicles

Recreational vehicles and commercial vehicles shall not be parked in front or exposed corner of a home for any reason other than loading and unloading. When RV's are parked on site they must be parked on the side of the home and be properly screened from the street. Wood screen fence is an acceptable screening mechanism, but may only be used alongside the house. RV parking will not be permitted within any yard exposed to the street.

### 6.2 Satellite Dishes

Satellite dishes are allowed provided the dish size does not exceed twenty-four (24") inches in diameter and the location of the dish is concealed to minimize visual impact.

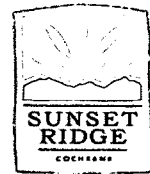

## 7. LANDSCAPING

### 7.1 Fencing

All fencing shall conform to the Cochrane Land Use Bylaw.

Fencing along the rear property lines will be supplied and installed by the developer for all laneless lots. Fencing along the side property lines on laneless lots is optional and will be the homeowner's responsibility as well as match the rear yard developer fence specifications to which it is intersecting.

See Appendix B for fencing specifications.

### 7.2 Front Yard Landscaping

The front yard landscaping must be completed within four months of the completion of the home but is subject to seasonal constraints.

### 7.3 Fire Pits and Outdoor Fireplaces

Fire pits and outdoor fireplaces will be permitted in the rear yard only and are to follow the Town of Cochrane Bylaws.

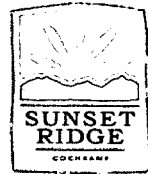

## 8. APPROVAL PROCESS

### 8.1 Preliminary Review

To achieve the desired traditional look in Five Lakes Phase 4A, designers are encouraged to create preliminary renderings or sketches of home plans and elevations to the Architectural Coordinator for preliminary review to ensure that they are on the right track.

### 8.2 Formal Application Submission

Builders will have to submit their plans to the Architectural Coordinator for architectural review and confirmation of compliance with these Architectural Guidelines before they will be permitted to apply to the Town of Cochrane for a building permit. The design coordinator will require the following information submitted via [www.archcontrol.com](http://www.archcontrol.com):

- Exterior colours including trim, siding and stone.
- Plot Plan (1:200 scale) showing the following:
  - Lot size
  - Building envelope
  - Setbacks
  - Lot coverage
  - Easement and utility rights of way
  - Property and house corner grades
- Construction Drawings (1/4"=1'; 3/16"=1')

**Builders must ensure all customer names are removed from their drawings before Architectural Submission.**

### 8.3 Final Inspection

At the completion of the exterior of the home, the builder is to request in writing a final inspection from the Architectural Coordinator to ensure that the home is in compliance with the design guidelines and the approved home plans.

### 8.4 Schedule of Applicable Fees

The fee for first Architectural Approval and Pre Approval will be paid by the Developer.

Any changes after the initial submission will be billed to the builder at the following unit costs:

- Change Requests.....\$ 75.00 /change
- Secondary Architectural Approval.....\$ 400.00
- Fee for consultation:
  - Senior AT.....\$ 170.00
  - Intermediate AT..... \$ 85.00





## 9. CONSTRUCTION REGULATIONS

### 9.1 Material and Equipment Storage

- Builders will be allowed to store their materials and equipment on site during construction but may not store on any other home sites.
- Items stored will have to be stored in an organized and covered manor to ensure site cleanliness.
- Builders must ensure that they do not trespass or disturb any other properties.
- Cleaning of paint, solvents, stains, etc will not be permitted on site.
- Concrete trucks may not clean chutes anywhere on site.
- Storage will not be permitted on any road or sidewalk.

### 9.2 Use of Site

- Construction debris and waste must be contained on site each day and removed at the end of the project.
- Debris may not be burned, dumped, or buried anywhere on site at any time.
- Site damage (curbs, site furniture, sidewalks, roadways, vegetation) will be the charged to the builder.
- Should a site not be maintained as these guidelines document, the developer reserves the right to rectify any deficiencies at the cost of the builder.

### 9.3 Vehicles and Parking

Utility trailers, etc. may be parked on site for the time of construction only, at the risk of the builder.

### 9.4 Other Notes

- Vegetation material, top soil, or similar materials may not be dumped on site at any time.
- Changing oil on any equipment or vehicles is not permitted on site.
- Alcohol and drugs are prohibited at all times on site.
- Erosion control will be the responsibility of the builder during construction.
- Builders are to ensure that sites are not access except via the provided entries.



## 10. DISCRETION

Notwithstanding anything else set out in these guidelines, the Developer, Decker Management Ltd. and IBI Group's Architectural Coordinators may apply their respective judgements when considering and approving anything regulated or controlled by these guidelines. In so doing, the Developer and the Architectural Coordinator may provide waivers of or relaxations to any matter set out in these guidelines in their sole and absolute unfettered discretion.

The Developer and the Architectural Coordinator reserve the right to accept home designs which, in the opinion of the Architectural Coordinator, meet the Guidelines set out herein in all respects. Furthermore, the Developer and the Architectural Coordinator reserve the right to alter or make amendments to the Architectural Guidelines at any time without notice.

### 10.1 No Right to Enforce

Only the Developer may enforce the guidelines, no purchaser of a lot in Sunset Ridge Phase 19B may enforce these guidelines.

### 10.2 Right to Amend

The Architectural Committee may from time to time amend these guidelines as it sees fit in its sole and absolute unfettered discretion.

### 10.3 No Trespassing

No person shall infringe upon, excavate on, destroy, paint, fill in, cut, remove or tamper with any lot in Sunset Ridge that is not their own. If done so the Architectural Committee has full right to take legal action for relief of any violation.



## 11. CONTACTS

### Architectural Coordinator

IBI GROUP  
400 – Kensington House  
1167 Kensington Crescent NW  
Calgary, Alberta T2N 1X7  
Tel: 403.270.5600  
Fax: 403.270.5610

### Engineering Consultant

Pasquini & Associates Consulting Ltd.  
200 - 6025 12th Street SE  
Calgary, Alberta T2H 2K1  
Tel: 403.452.7677  
Fax: 403.452.7660

### Developer

Sunset Properties  
c/o Melcor Developments Ltd.  
300 - 1204 Kensington Road NW  
Calgary, Alberta T2N 3P5  
Tel: 403.283.3556  
Fax: 403.270.0538

### Architectural Committee

The Developer until otherwise established.



# APPENDIX A

## APPROVED SIDING COLOURS





## Approved Siding Colours

### Gentek - Sequoia

Venetian Red  
Dark Drift  
Saddle Brown  
Mountain Arbor  
Moonlit Moss  
Coastal Blue  
Midnight Surf  
Windswept smoke  
Snow White (secondary only, not with white trim)

### Royal - Colorscapes

Rustic Red  
Heritage Blue  
Midnight Surf  
Granite  
Natural Cedar  
Olivewood  
Walnut  
Shamrock  
Ironstone  
Wedgewood  
Cocoa  
Redwood  
White (secondary only, not permitted with white trim)

### Mitten - Sentry (ACT)

Olive Green  
Aviator Green  
Burnt Orange  
Richmond Red  
Annapolis Blue  
Eggplant  
Coffee Bean  
Caribou Brown  
Chestnut Brown  
Khaki Brown  
Sahara Brown  
Muskoka Green  
Rain Forest  
Rockaway Grey  
Frost (secondary only, not permitted with white trim)

### Kaycan

Ivy Green  
Pecan  
Mahogany  
Midnight Blue  
Colonial Red  
Spice  
Brick  
Evergreen  
Cabot Brown  
Cabot Blue  
Cabot Red  
Pebble  
Stone Crest  
White (secondary only, not permitted with white trim)

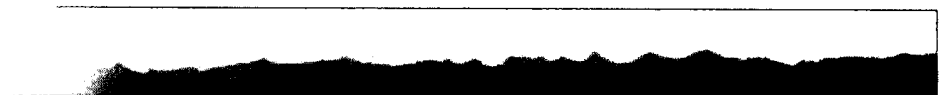



# APPENDIX B

## FENCING

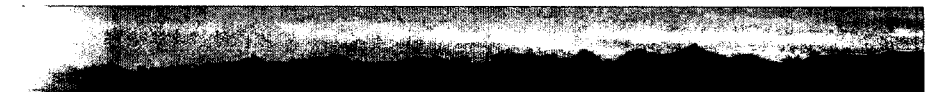

# FLANKAGE AND DECORATIVE WOOD FENCING DETAIL

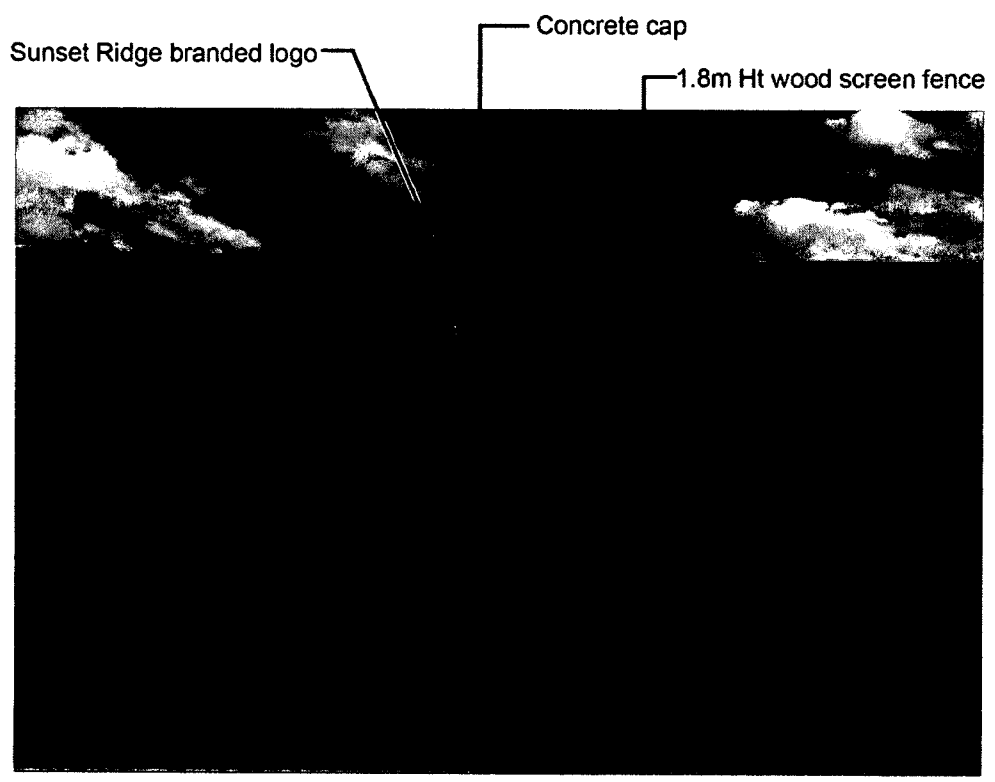
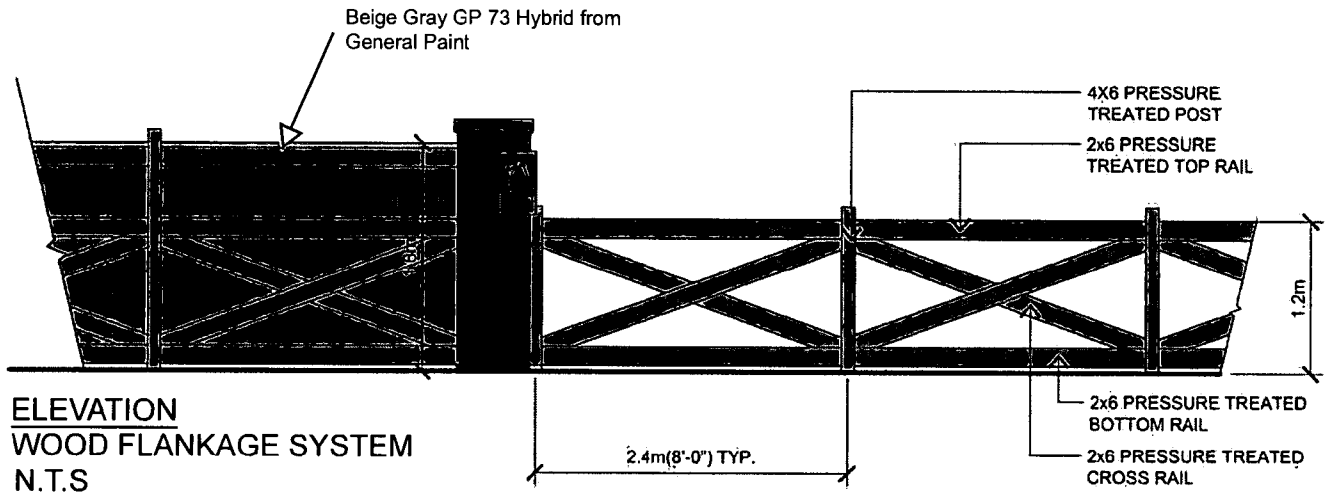

# WROUGHT IRON FENCING DETAIL

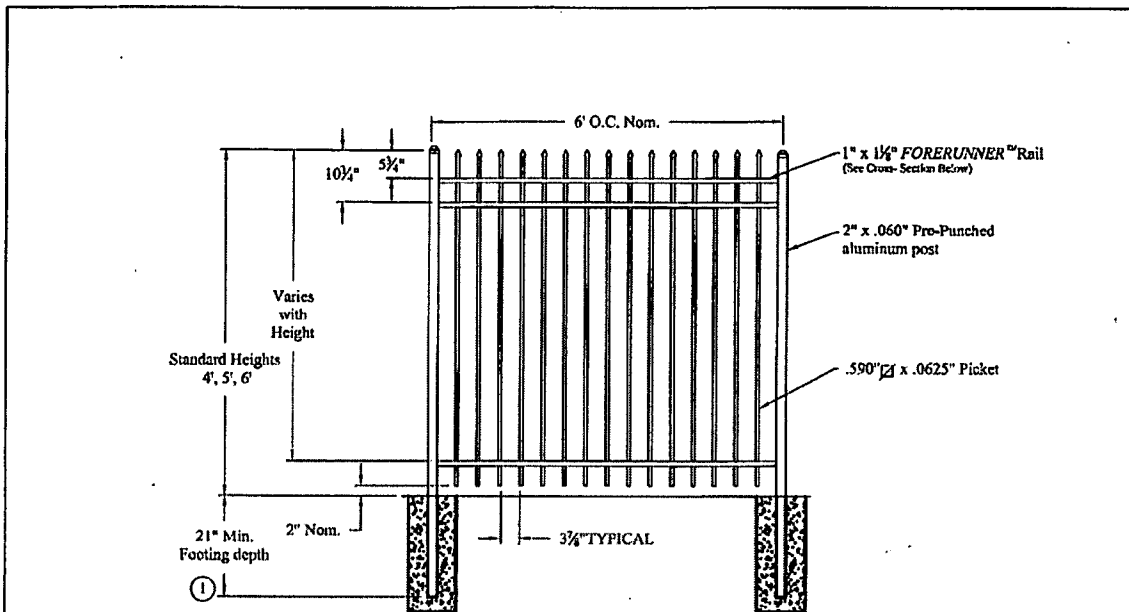

NOTES:  
1. Post footing available in 21" or 33" depths.

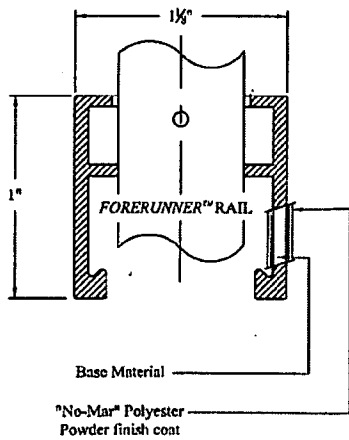

**INTERNAL RETAINING ROD**  
Variable pitch connection system for ease of installation, high angle bias ability and elimination of unsightly external fasteners.

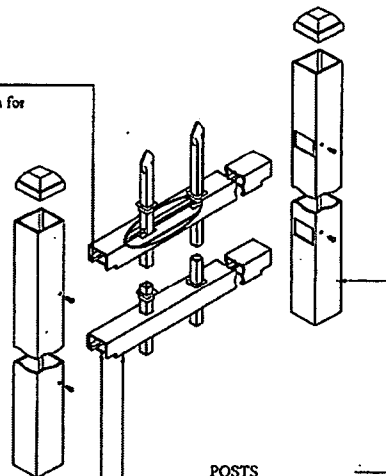

**INTERIOR GUIDE CHANNEL**  
Channel forms lower limit of raceway for retaining rod and allows for high angle bias ability.

**FORERUNNER RAIL**  
"U"-Channel specially formed high strength architectural shape.

**POSTS**  
Special extruded aluminum shape with reinforced corners; pre-punched to eliminate brackets.

Values shown are nominal and not to be used for installation purposes. See product specification for installation requirements.

FILE  
**ECHELON CLASSIC 3-RAIL**

DR: CI    SH: 1 of 1    SCALE: DO NOT SCALE  
CK: ME    Date: 6/25/10    REV: b



**AMERISTAR®**

1555 N. Mingo  
Tulsa, OK 74116  
1-888-333-3422  
www.ameristarfence.com

CISO



# APPENDIX C

## LAND USE BYLAW

Refer to the Municipal Clerk of the Town of Cochrane for the official Bylaw and all amendments thereto.





151263909

151263909 REGISTERED 2015 10 09  
CAVE - CAVEAT  
DOC 3 OF 3 DRR#: C0F2516 ADR/CALGYSEL  
LINC/S: 0036854157 +

3